

Data Sheet



Article number: 02150000062

Description: Sealing Clamp S 62 W1

Measures

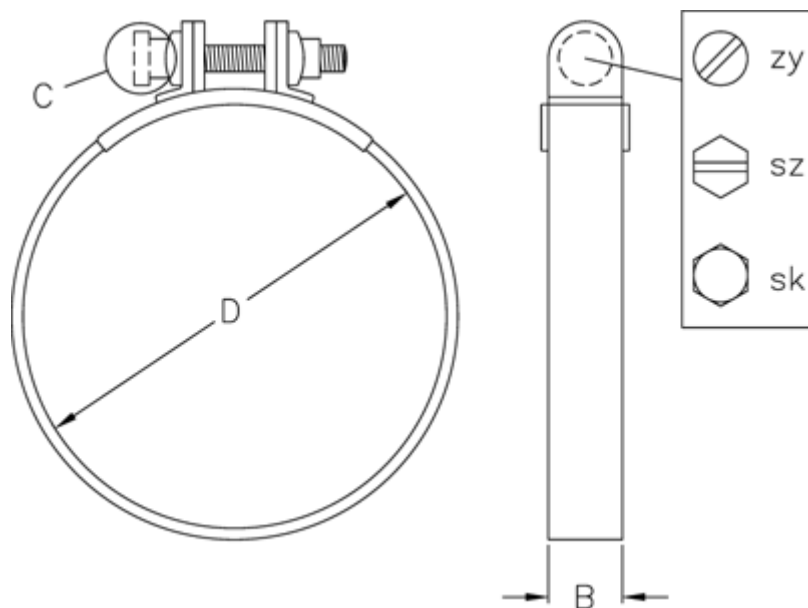

C (screw type) = SZ

Diameter D = 62

Width B = 20